

MX 600/U/MX 50

# STEREO POWER AMPLIFIER

# MX-600/U/MX-50

## SERVICE MANUAL

### IMPORTANT NOTICE

This manual has been provided for the use of authorized Yamaha Retailers and their service personnel. It has been assumed that basic service procedures inherent to the industry, and more specifically Yamaha Products, are already known and understood by the users, and have therefore not been restated.

**WARNING:** Failure to follow appropriate service and safety procedures when servicing this product may result in personal injury, destruction of expensive components and failure of the product to perform as specified. For these reasons, we advise all Yamaha product owners that all service required should be performed by an authorized Yamaha Retailer or the appointed service representative.

**IMPORTANT:** The presentation or sale of this manual to any individual or firm does not constitute authorization, certification or recognition of any applicable technical capabilities, or establish a principle-agent relationship of any form.

The data provided is believed to be accurate and applicable to the unit(s) indicated on the cover. The research, engineering, and service departments of Yamaha are continually striving to improve Yamaha products. Modifications are, therefore, inevitable and specifications are subject to change without notice or obligation to retrofit. Should any discrepancy appear to exist, please contact the distributor's Service Division.

**WARNING:** Static discharges can destroy expensive components. Discharge any static electricity your body may have accumulated by grounding yourself to the ground buss in the unit (heavy gauge black wires connect to this buss).

**IMPORTANT:** Turn the unit OFF during disassembly and parts replacement. Recheck all work before you apply power to the unit.

## ■ CONTENTS

TO SERVICE PERSONNEL .....	1	DISASSEMBLY PROCEDURES .....	5
SPECIFICATIONS .....	1	ADJUSTMENTS .....	5
FRONT PANELS .....	2	PRINTED CIRCUIT BOARD .....	6 ~ 10
REAR PANELS .....	3	WIRING .....	11
BLOCK DIAGRAM .....	4	SCHEMATIC DIAGRAM .....	12
INTERNAL VIEW .....	4	PARTS LIST .....	13 ~ 19

## TO SERVICE PERSONNEL

- Critical Components Information.**  
Components having special characteristics are marked  $\Delta$  and must be replaced with parts having specifications equal to those originally installed.
- Leakage Current Measurement (For 120V Model Only).**  
When service has been completed, it is imperative that you verify that all exposed conductive surfaces are properly insulated from supply circuits.
  - Meter impedance should be equivalent to 1500 ohm shunted by 0.15 $\mu$ F.
  - Leakage current must not exceed 0.5mA.
  - Be sure to test for leakage with the AC plug in both polarities.

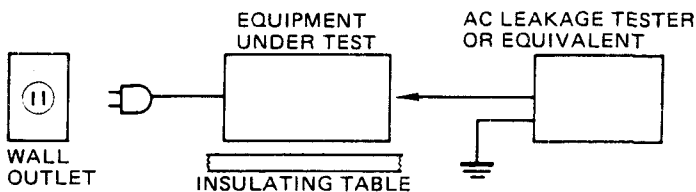

### • POLARIZATION (U, C models only)

This amplifier product is equipped with a polarized alternating current line plug (a plug having one blade wider than the other). This plug will fit into the power outlet only one way. This is a safety feature.

## SPECIFICATIONS

Minimum RMS Output Power per Channel	
20Hz ~ 20kHz	
0.003% THD, 8 $\Omega$	135W (U, C), 125W (R, A, B, G)
0.007% THD, 6 $\Omega$	160W (U, C), 150W (R, A, B, G)
0.02% THD, 4 $\Omega$	190W (U, C, R, A)

Dynamic Power per Channel (by IHF Dynamic Headroom measuring method)	
8 $\Omega$	220W (U, C), 175W (R, A, B, G)
6 $\Omega$	265W (U, C), 220W (R, A, B, G)
4 $\Omega$	360W (U, C), 290W (R, A, B, G)
2 $\Omega$	480W (U, C), 390W (R, A, B, G)
1 $\Omega$	500W (U, C), 420W (R, A, B, G)

DIN Standard Output Power per Channel	
1kHz, 1% THD, 4 $\Omega$	215W (G)

Dynamic Headroom	
8 $\Omega$	2.12dB
6 $\Omega$	2.19dB
4 $\Omega$	2.78dB

IEC Power (1kHz, 0.01% THD)	
8 $\Omega$	140W (G)
6 $\Omega$	170W (G)

Power Band Width	
0.03% THD, 62.5W, 8 $\Omega$	10kHz ~ 60kHz

Damping Factor	
8 $\Omega$ , 1kHz	70

Input Sensitivity/Impedance	
MAIN IN	1.14V/60k $\Omega$

Frequency Response (20Hz ~ 20kHz)	
MAIN IN	+0, -0.2dB

Total Harmonic Distortion	
20Hz ~ 20kHz	
MAIN IN TO SP OUT (62.5W/8 $\Omega$ )	0.003%

Intermodulation Distortion	
Rated Output/8 $\Omega$	0.003%

Signal to Noise Ratio (IHF-A Network)	
MAIN IN (Shot)	123dB
MAIN IN (5.1k $\Omega$ terminated)	119dB

Residual Noise (IHF-A Network)	
	16 $\mu$ V

Channel Separation (Vol. -30dB)	
Input Shorted (1kHz/10kHz)	89dB/70dB

Power Supply	
	AC220/240V, 50Hz (B, G)
	AC110/120/220/240V, 50/60Hz (R)
	AC240V, 50Hz (A)
	AC120V, 60Hz (U, C)

Power Consumption	
	650W, 800VA (U, C)
	500W (R)
	650W (A, B, G)

AC Outlet	
Un Switched x 1	200W max. (U, C, R)

Dimensions (W x H x D)	
	435 x 170 x 425mm (17-1/8" x 6-11/16" x 16-3/4")

Weight	
	13kg (28 lbs 11 oz)

\*Specifications are subject to change without notice.

- (U) ..... U.S.A. Model
- (C) ..... Canadian Model
- (A) ..... Australian Model
- (B) ..... British Model
- (G) ..... European Model
- (R) ..... General Model

### • Dimensions

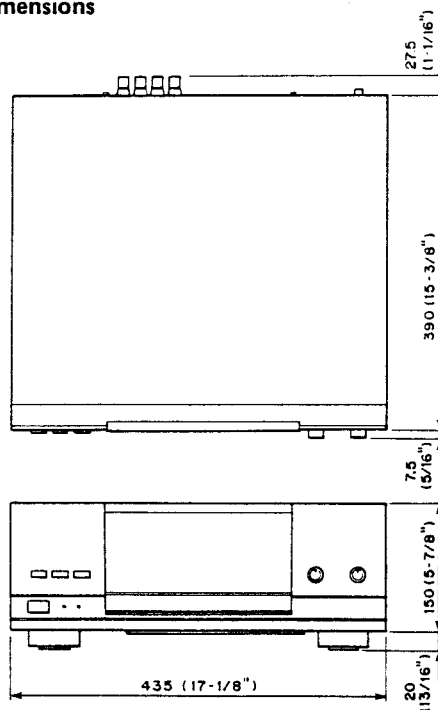

Unit : mm (inh)

## FRONT PANELS

- MX-600 (General & Australian models)

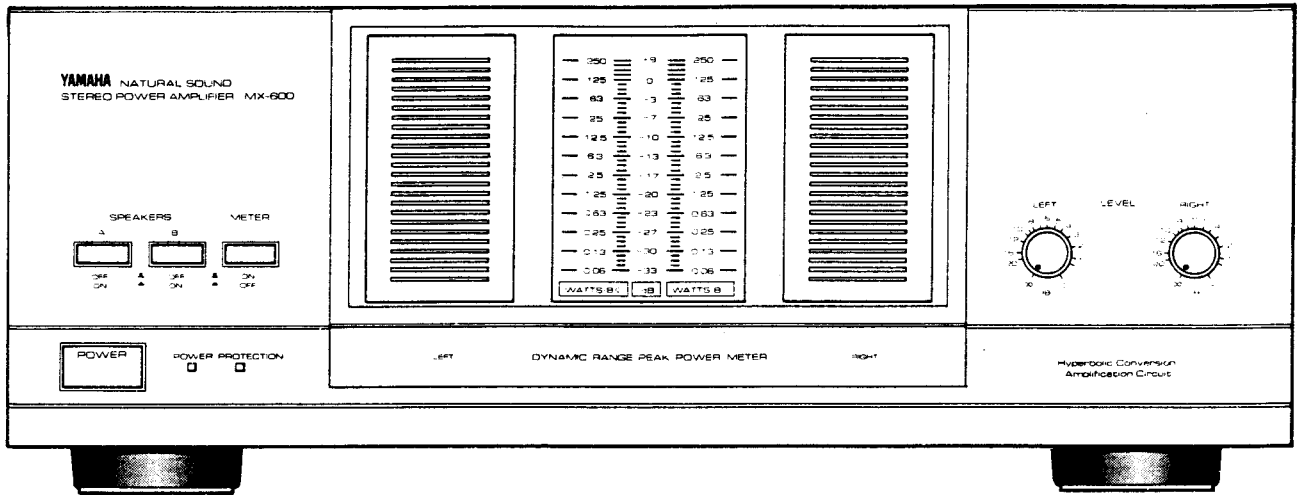

- MX-600U (U.S.A. & Canadian models)

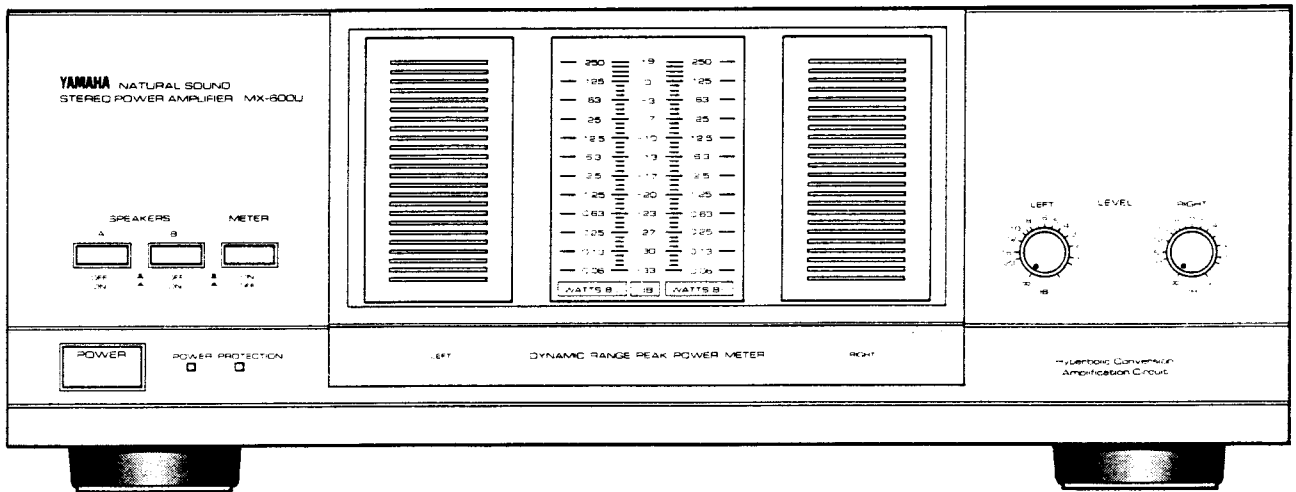

- MX-50 (British & European models)

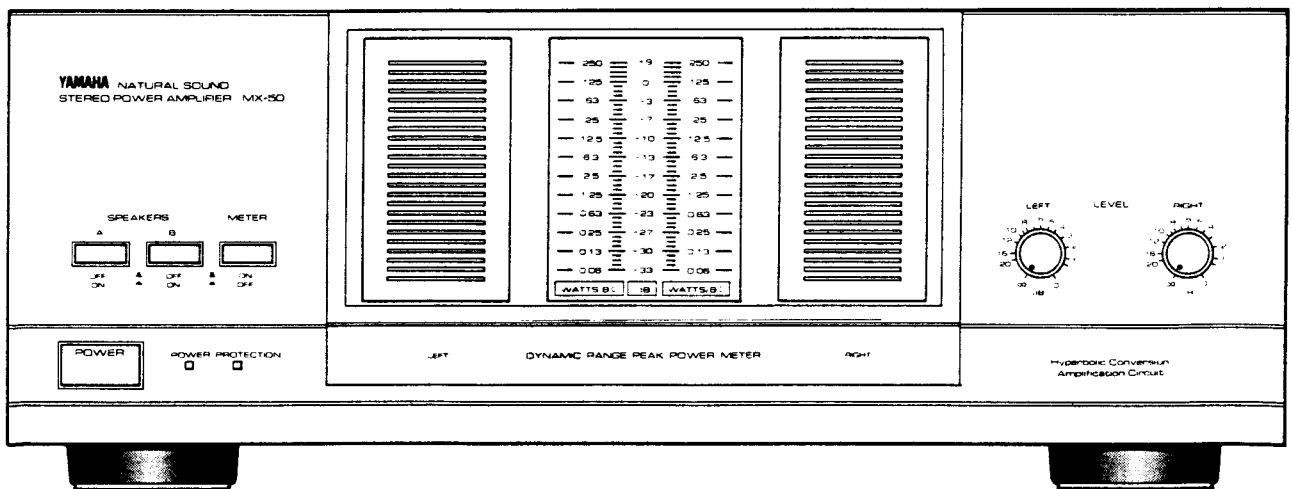

## REAR PANELS

### General model

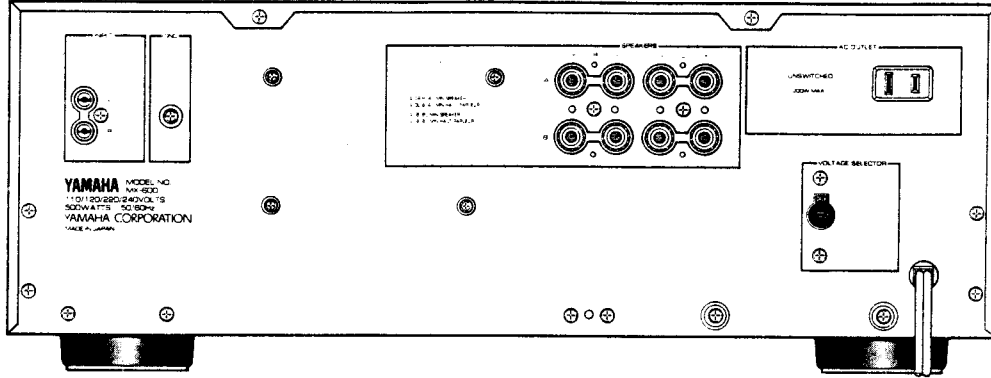

### Australian model

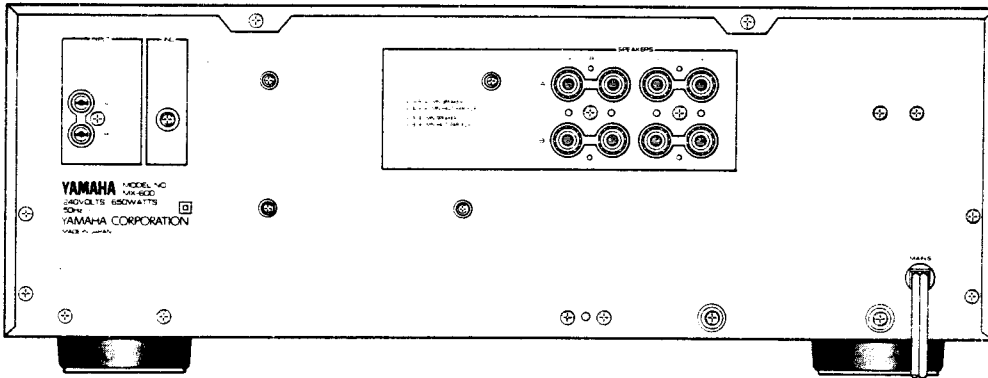

### U.S.A. & Canadian models

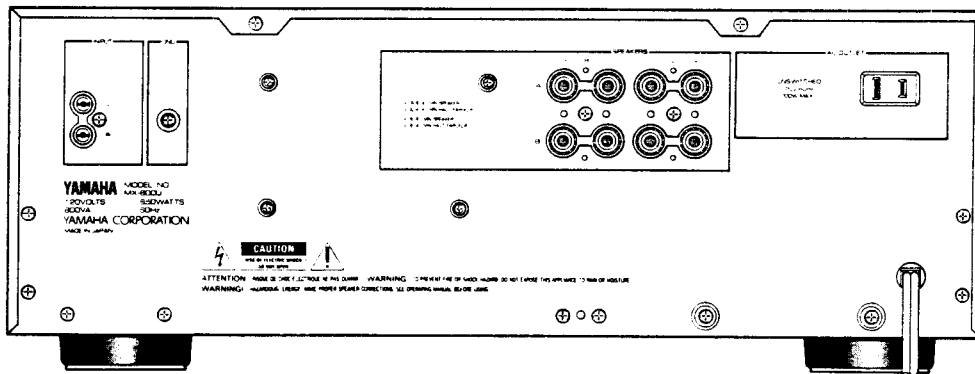

### British & European models

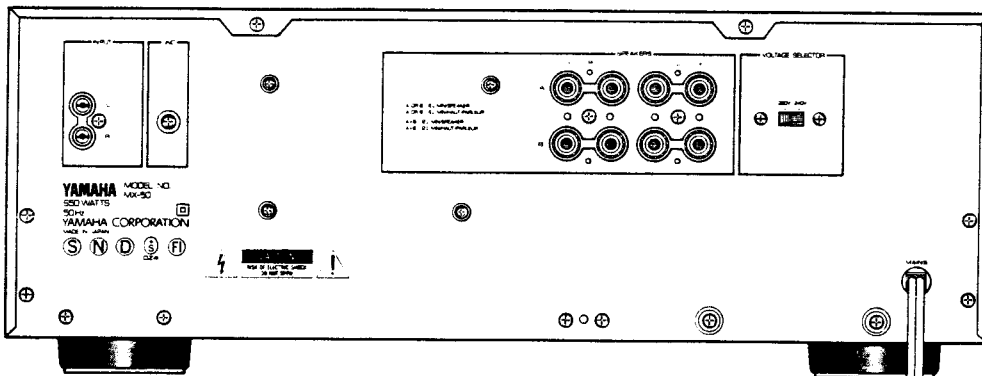

**■ BLOCK DIAGRAM**

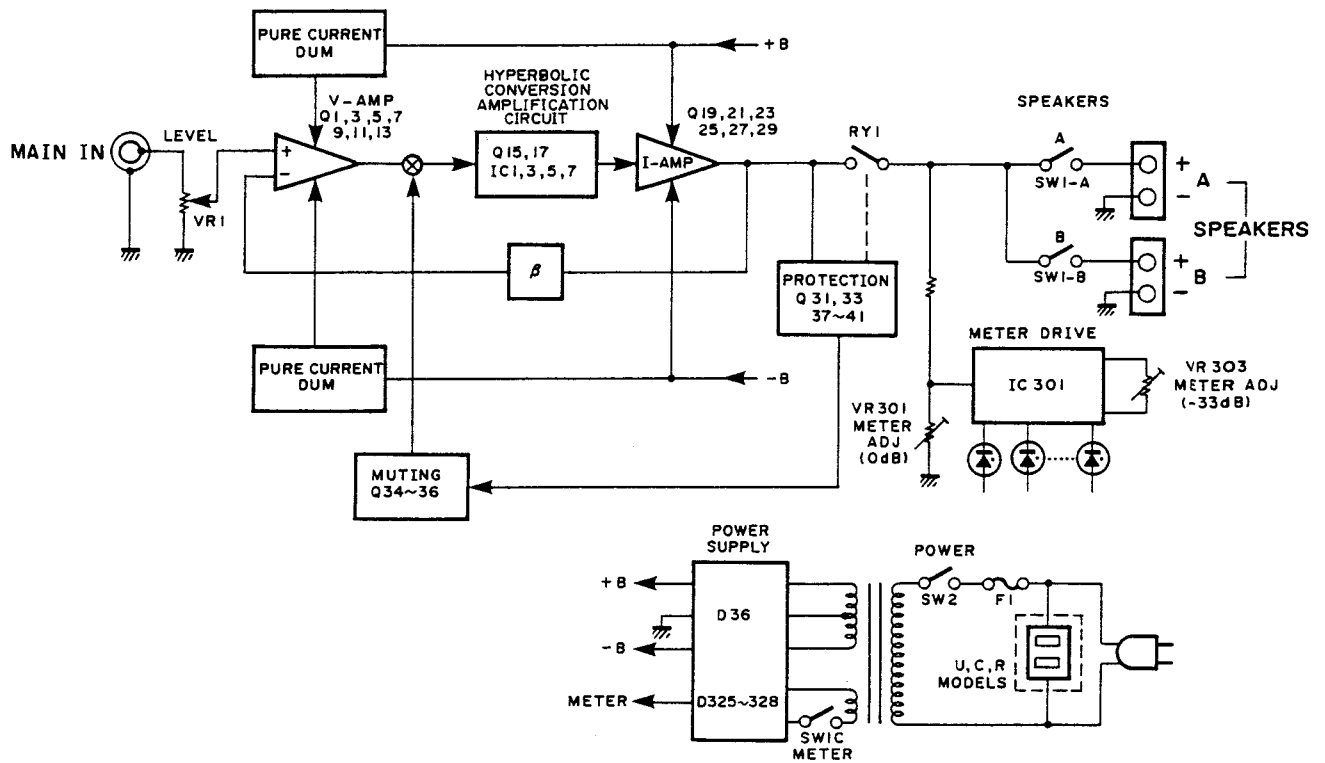

**■ INTERNAL VIEW**

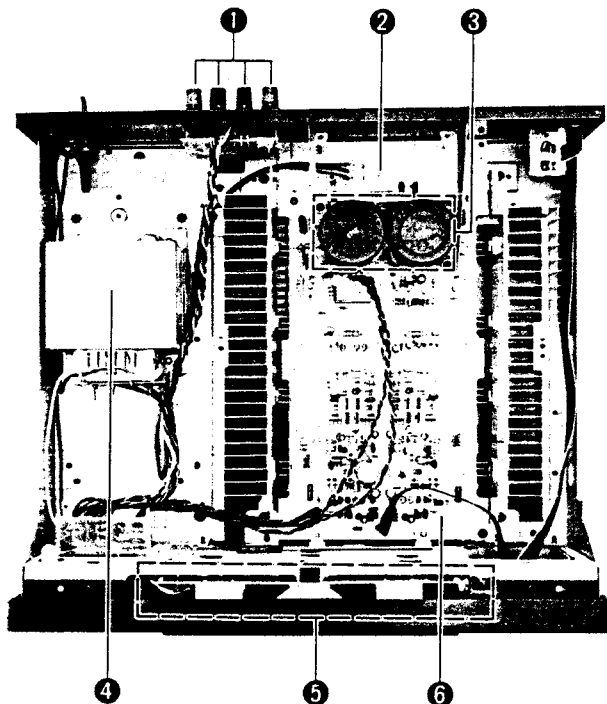

- ① SPEAKER TERMINAL
- ② DIODE BRIDGE : 4D 4B41
- ③ ELECTROLYTIC CAP. SET
- ④ POWER TRANSFORMER
  - U model : XE21 7001
  - C model : XE21 8001
  - R model : XE21 9001
  - A model : XE22 0001
  - B, G models : XE22 1001
- ⑤ METER UNIT
- ⑥ MAIN CIRCUIT BOARD (1)

## DISASSEMBLY PROCEDURES

### 1. Removal of Top Cover

Remove 6 screws (①) in Fig. 1. and slide the Top Cover back.

### 2. Removal of Bottom Cover

Remove 6 screws (②) in Fig. 1.

### 3. Removal of Front Panel

Remove 5 screws (③) in Fig. 1.

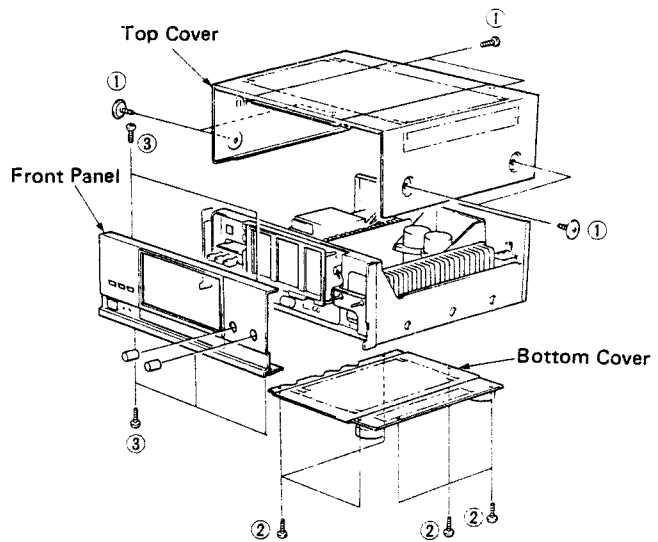

Fig. 1

## ADJUSTMENTS

### ● IDLING CURRENT ADJUSTMENT

Wait 2 minutes after power ON to stabilize amplifier operation without signal.

Adjust VR3 (LcH) and VR4 (RcH) so that the voltage across the terminals of R87 (either R89, R91, R93) and R88 (either R90, R92, R94) come to  $10\text{mV} \pm 1\text{mV DC}$ .

	Test Points	Adjustment Points	Rating
LcH	Across the terminals of R87	VR 3	$10\text{mV} \pm 1\text{mV DC}$
RcH	Across the terminals of R88	VR 4	

### ● METER LEVEL ADJUSTMENT

- 1) Amplifier load : No load or  $8\Omega$ .
- 2) Apply a 1kHz sine wave signal from LINE IN so that Speaker output voltage is 0.69V AC.
- 3) Adjust VR303, 304 so that  $-33\text{dB}$  of the meter light up.
- 4) Reduce the signal level 0.5dB (0.65V AC). Confirm that  $-33\text{dB}$  segment fades out.
- 5) Apply a 1kHz sine wave signal from LINE IN so that Speaker output voltage is 31.6V AC.
- 6) Adjust VR301, 302 so that 0dB of the meter light up.
- 7) Reduce the signal level 0.5dB (29.8V AC). Confirm that 0dB segment fades out.
- 8) Confirm that  $-33\text{dB}$  segment fades out at no signal condition.

### ● TEST POINTS

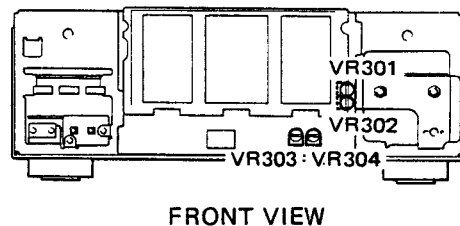
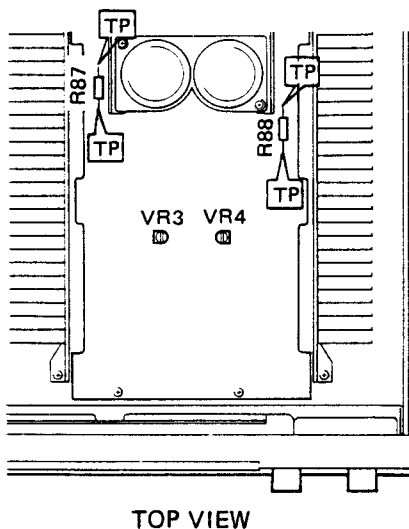

**PRINTED CIRCUIT BOARD (Pattern side)** Note) 文字面: Component side

Note) \* marked

	U, C, R, A	B, G
C47 ~ 50	OPEN	4700P/100
C51, 52, 61	OPEN	0.01
R143, 144, 146, 147	OPEN	10
C57	OPEN	0.1/250
C62	OPEN	10P/500

Main Circuit Board (1)

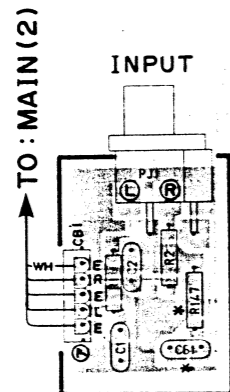

Main Circuit Board (5)

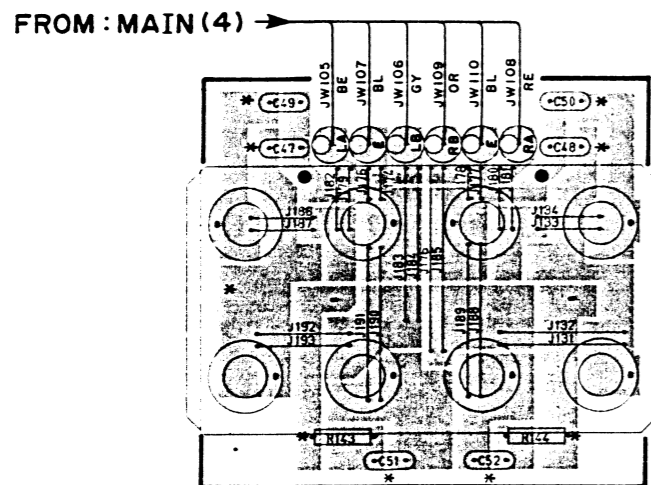

Main Circuit Board (6)

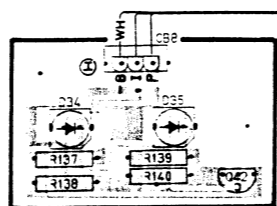

POWER PROTECTION

FROM: MAIN (4)

Main Circuit Board (3)

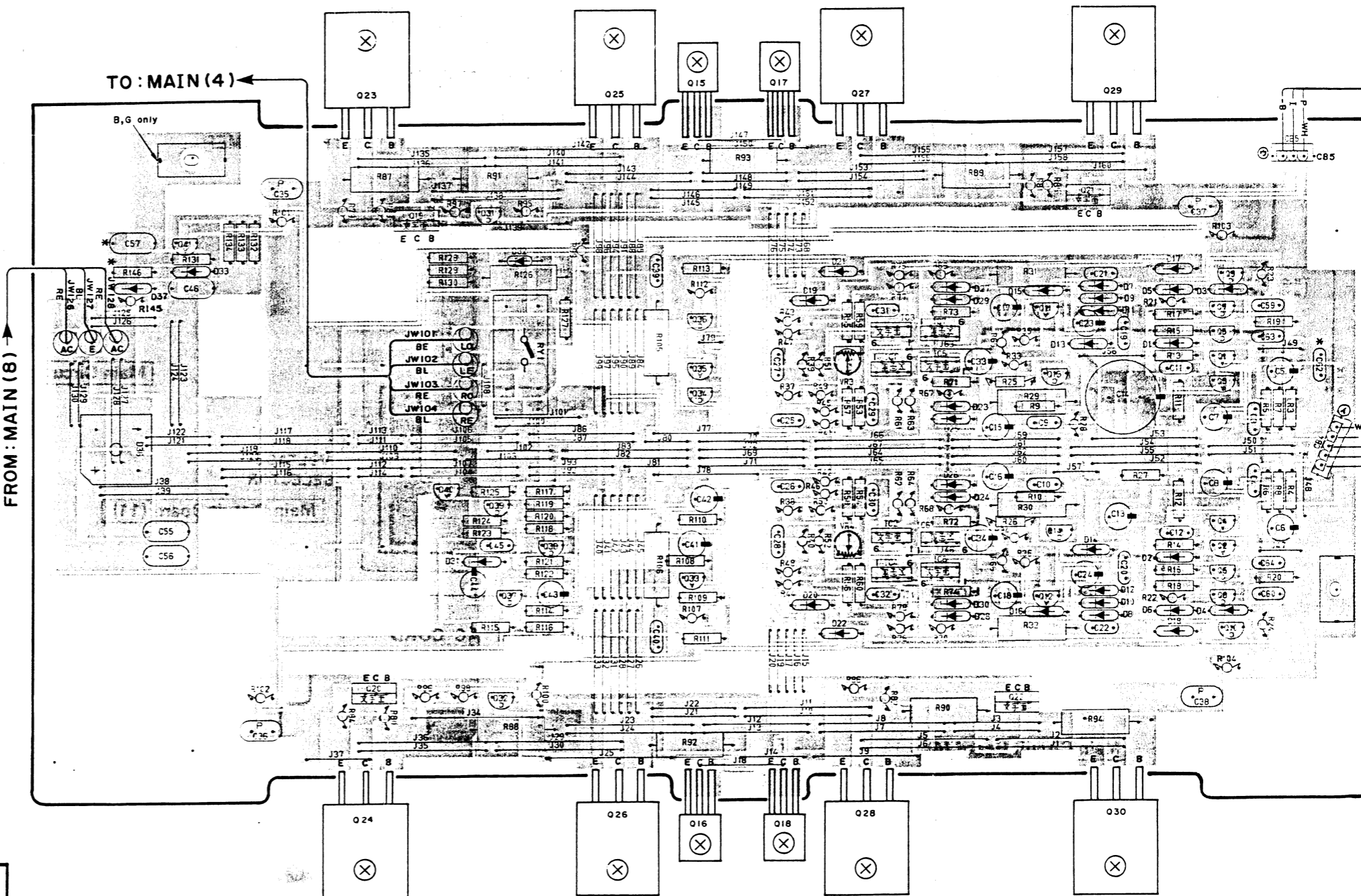

Main Circuit Board (2)

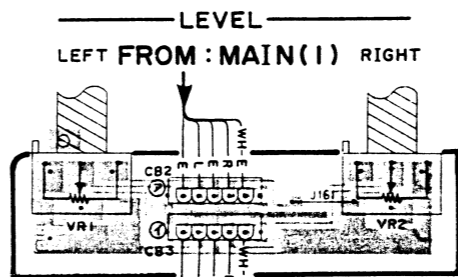

TO: MAIN (3)

Main Circuit Board (8)

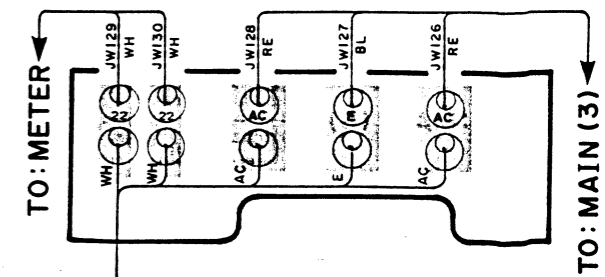

FROM: POWER TRANSFORMER

PRINTED CIRCUIT BOARD (Pattern side)

A, U, C MODEL

R MODEL

G, B MODEL

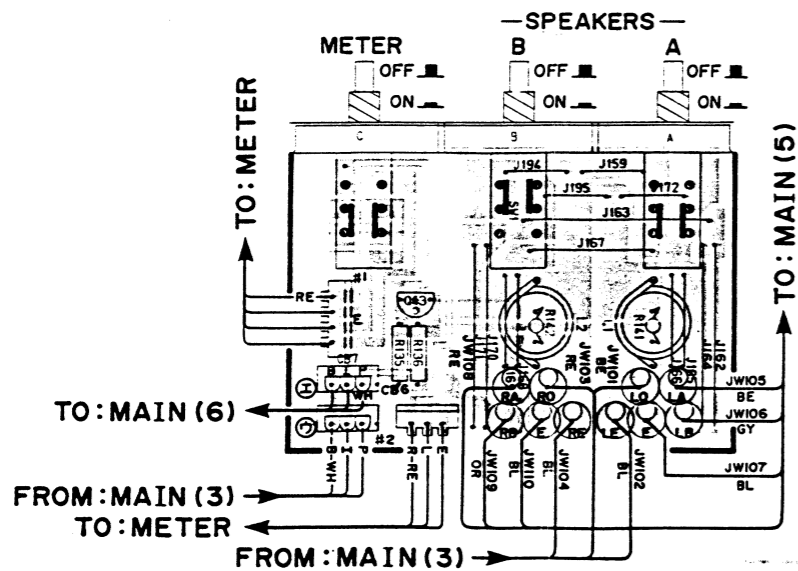
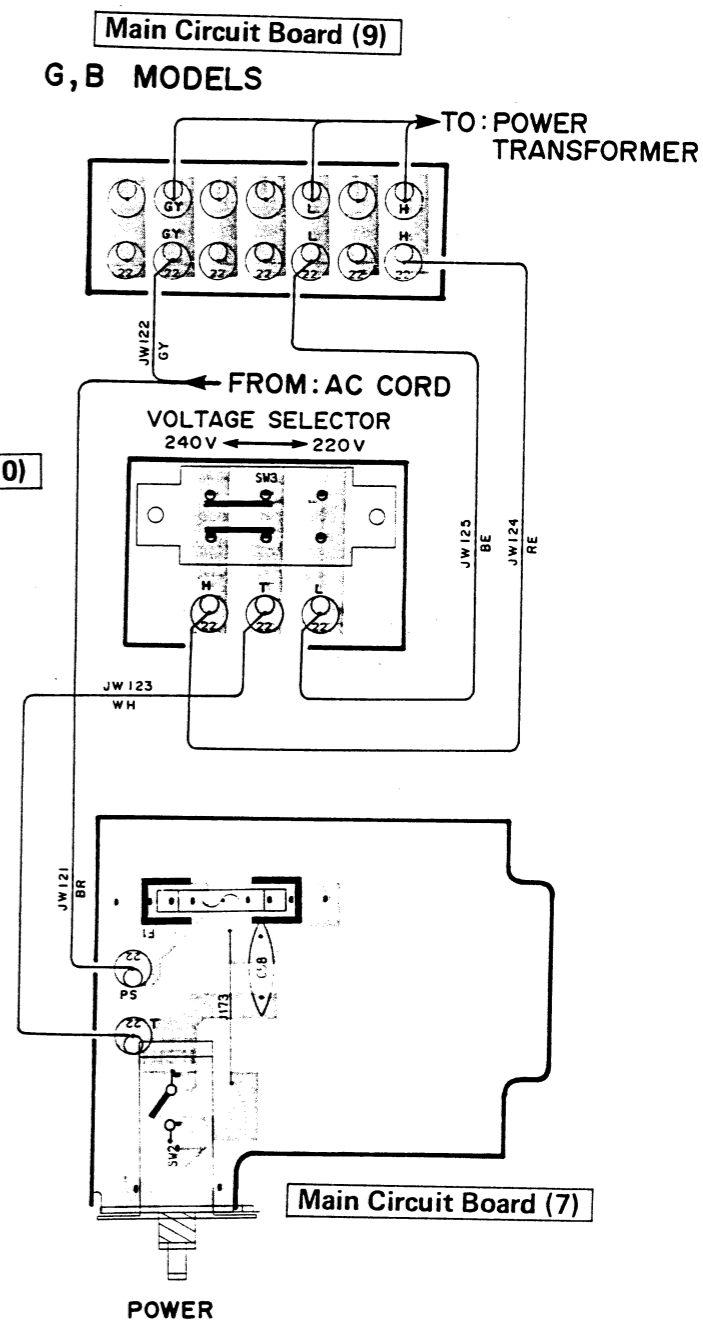
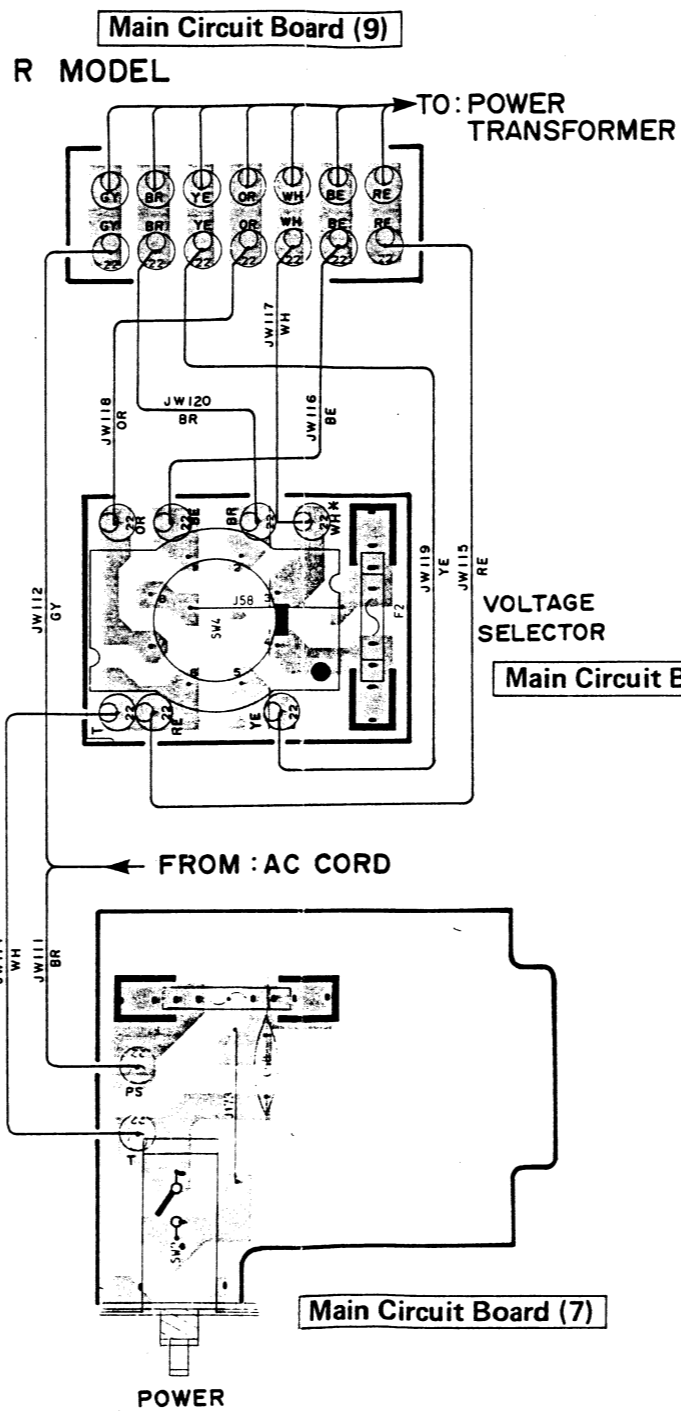
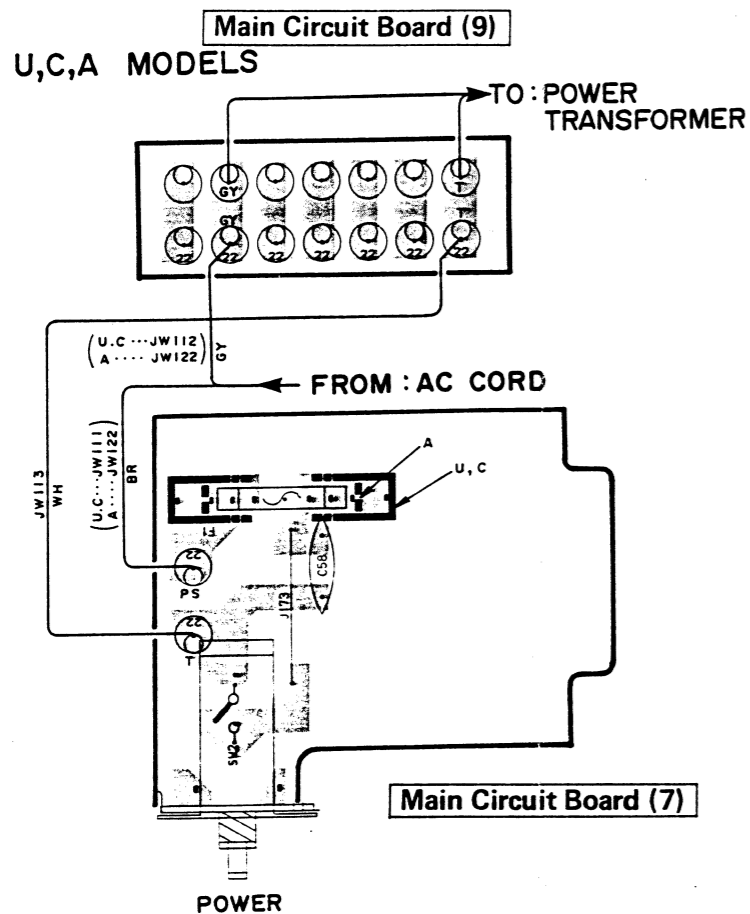

1  
2  
3  
4  
5  
6



■ WIRING

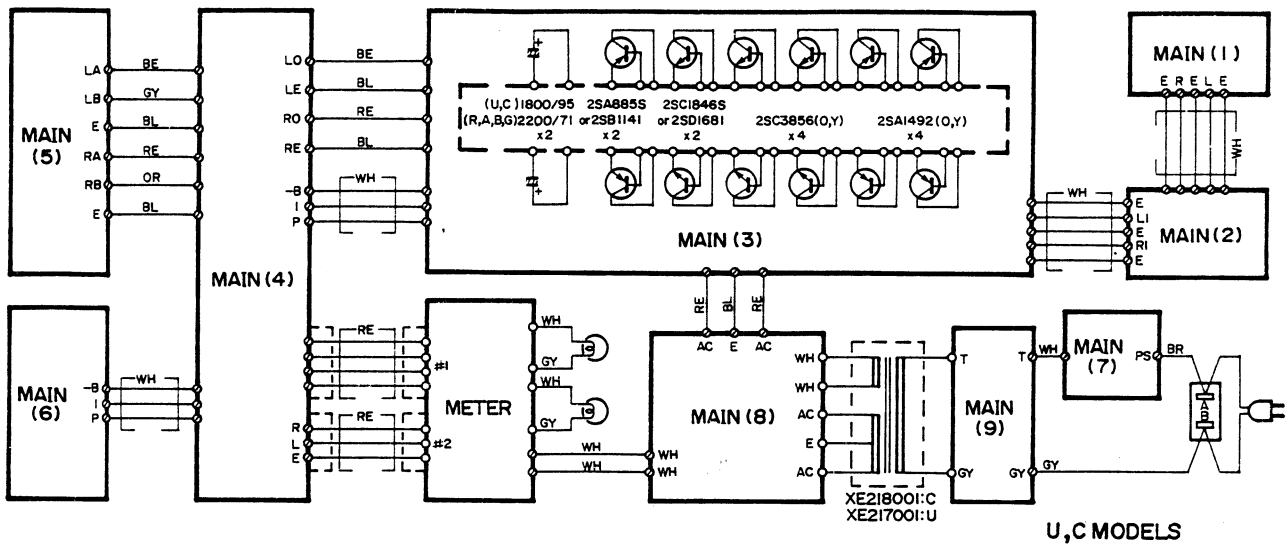

A MODEL

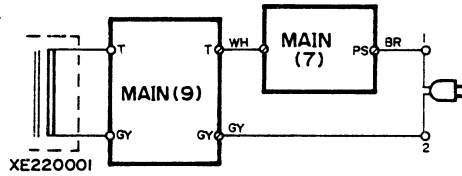

G, B MODEL

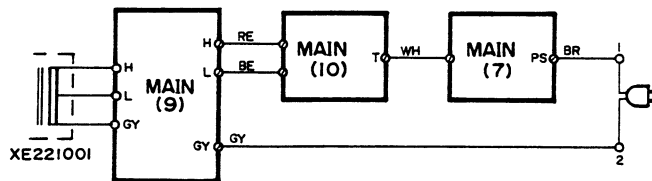

R MODEL

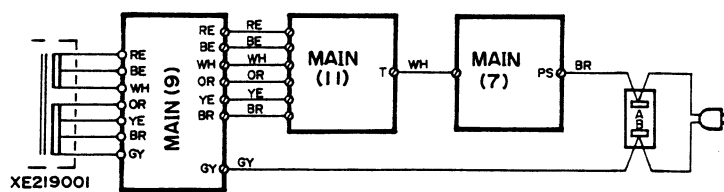

A

B

C

D

E

MX-600/U/MX-50

# PRINTED CIRCUIT BOARD (Pattern side)

## Meter Circuit Board

1

2

3

4

5

6

7

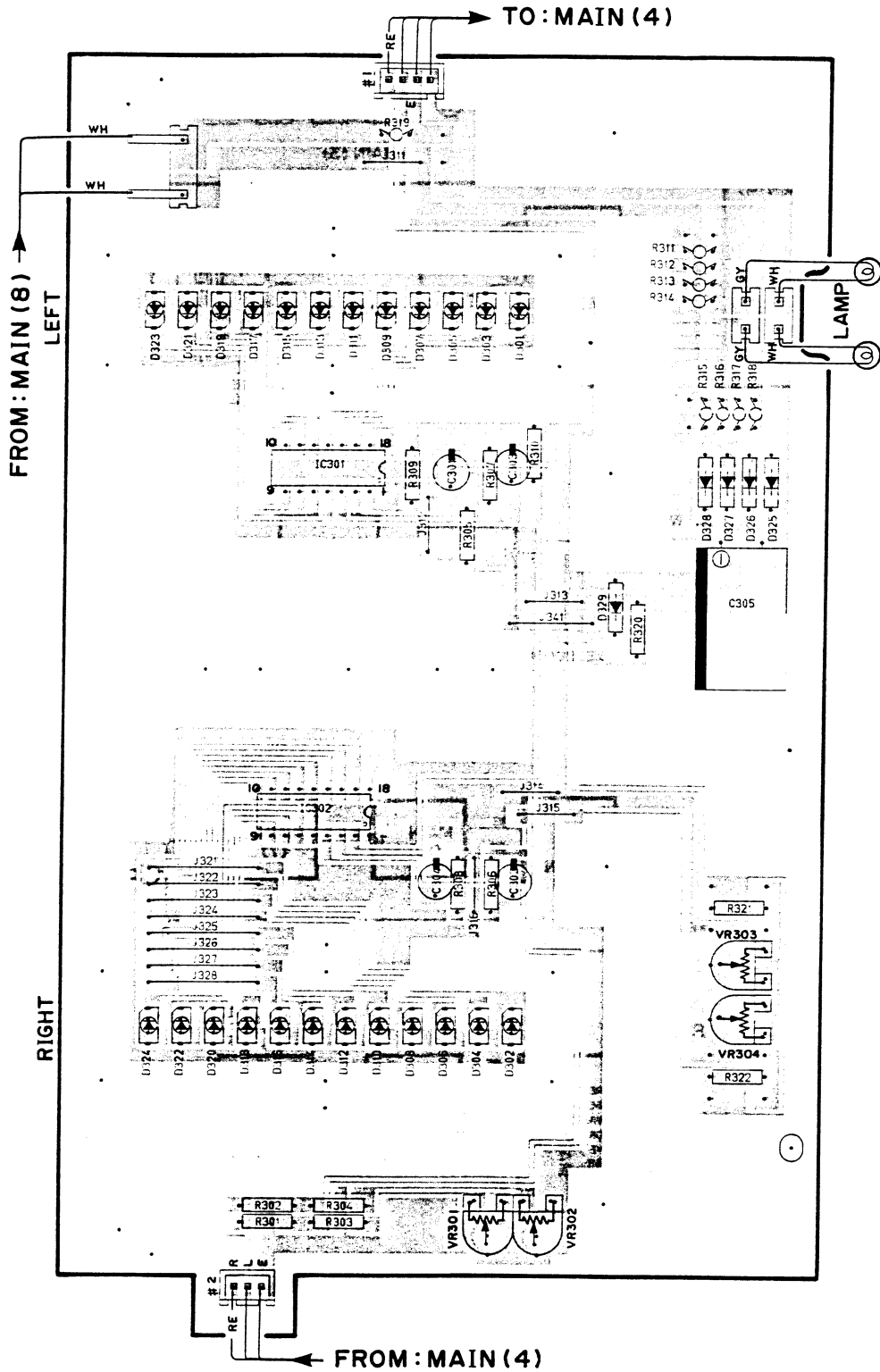

# SCHEMATIC DIAGRAM

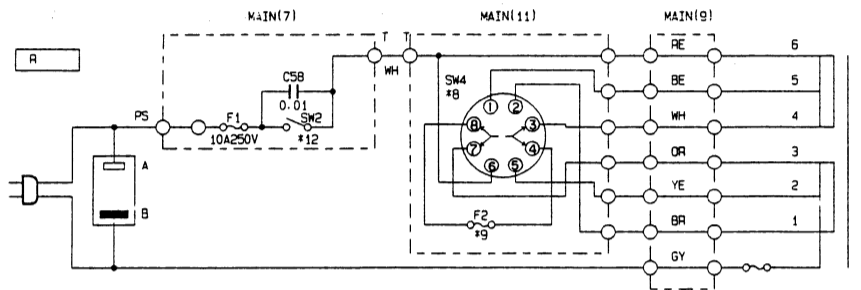
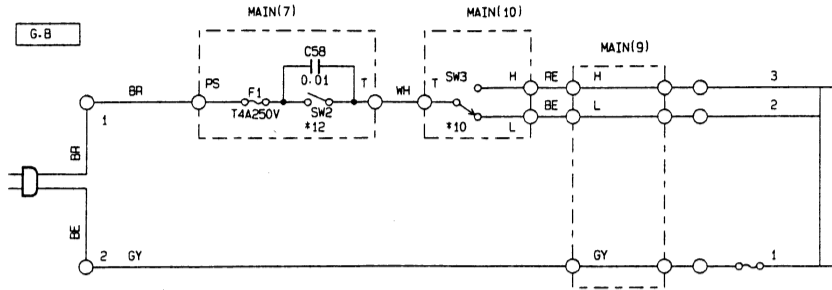
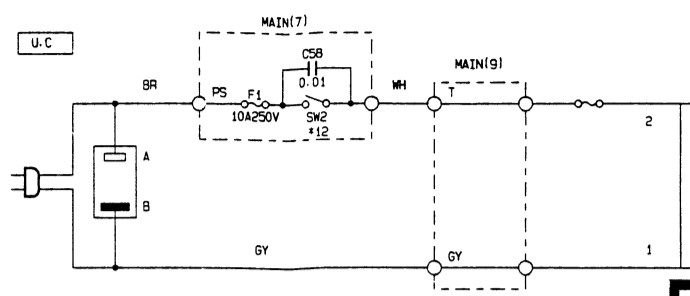
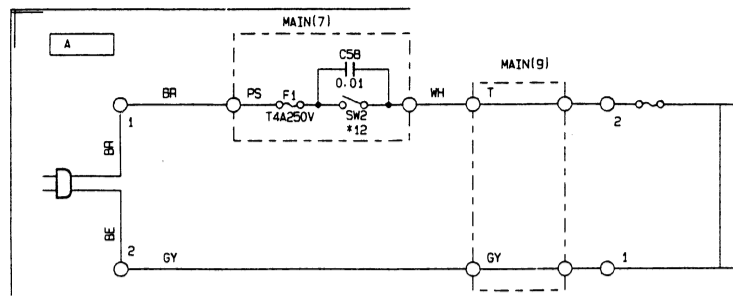

V-AMP

HCA

I-AMP

## NOTICE

- (U)..... U.S.A model
- (C)..... Canadian model
- (A)..... Australian model
- (G)..... European model
- (B)..... British model
- (R)..... General model

PNP TRANSISTOR	
NPN TRANSISTOR	
DIODE	1S1555

## PIN CONNECTION DIAGRAM OF TRANSISTORS, DIODES AND ICs.

2SA1492 (O, Y) 2SC3856 (O, Y)	2SA1349 (GR, BL) 2SC3381 (GR, BL)	2SA970 (GR, BL) 2SC2240 (GR, BL) 2SC1815 (Y)	2SA1306	2SA1145 (O, Y) 2SC2705 (O, Y)	2SA885 (S) 2SC1846 (S)	1SR-35-100A HZ6C1L 1S1555 1SS82 HZ24-2 HZ16-3L	4D4B41	SLV-56URC3H SLV-31VC5	BA681A

IC301, 302: BA681A  
Meter Drive

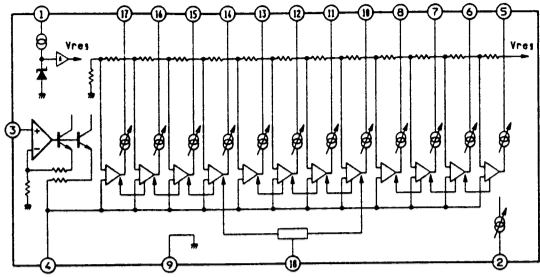

POWER SUPPLY

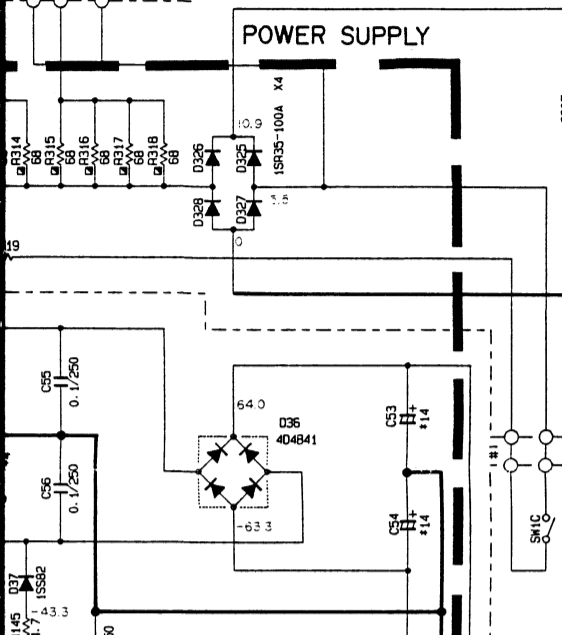

METER DRIVER

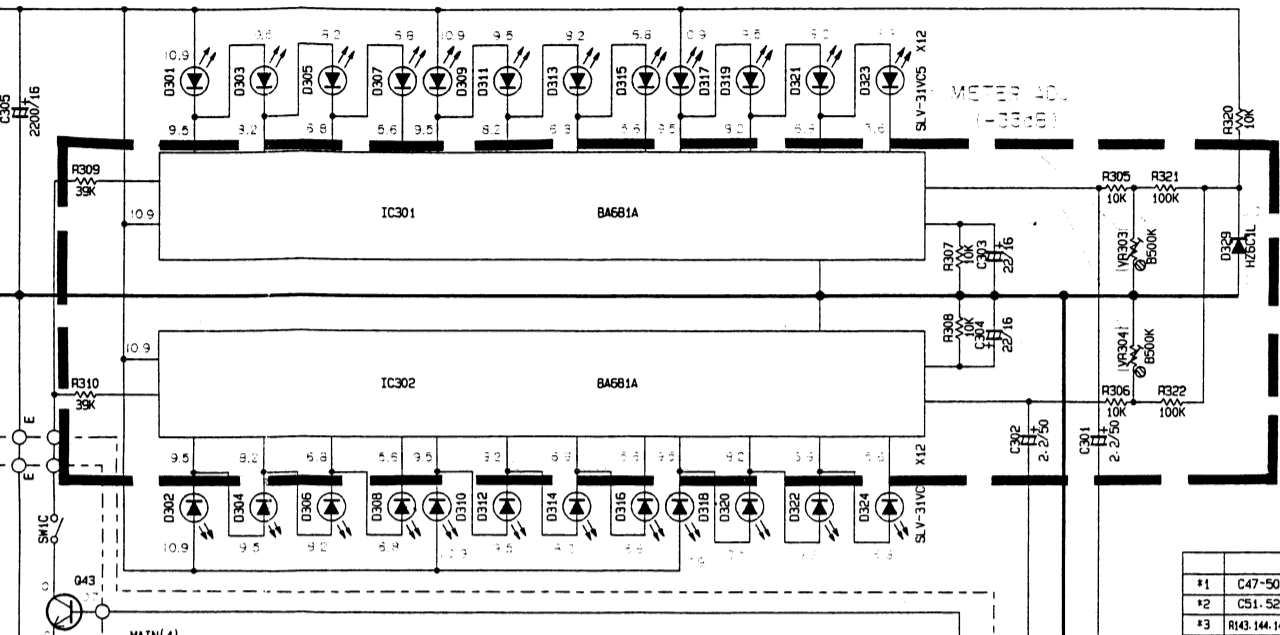

PROTECTION

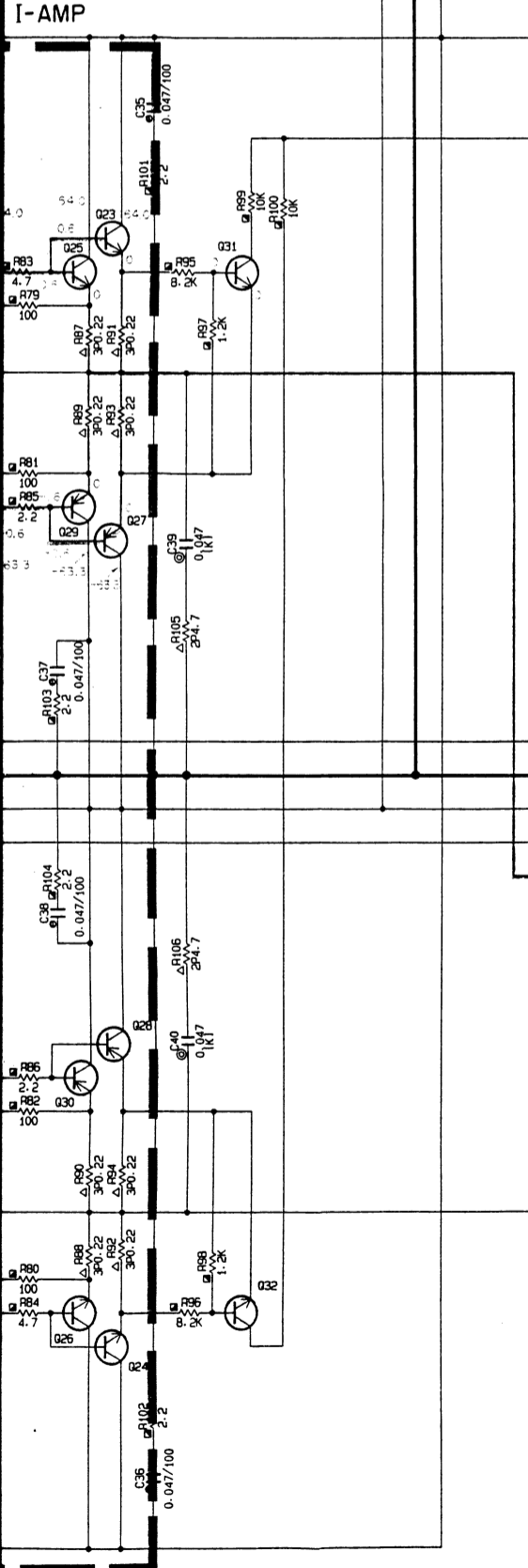
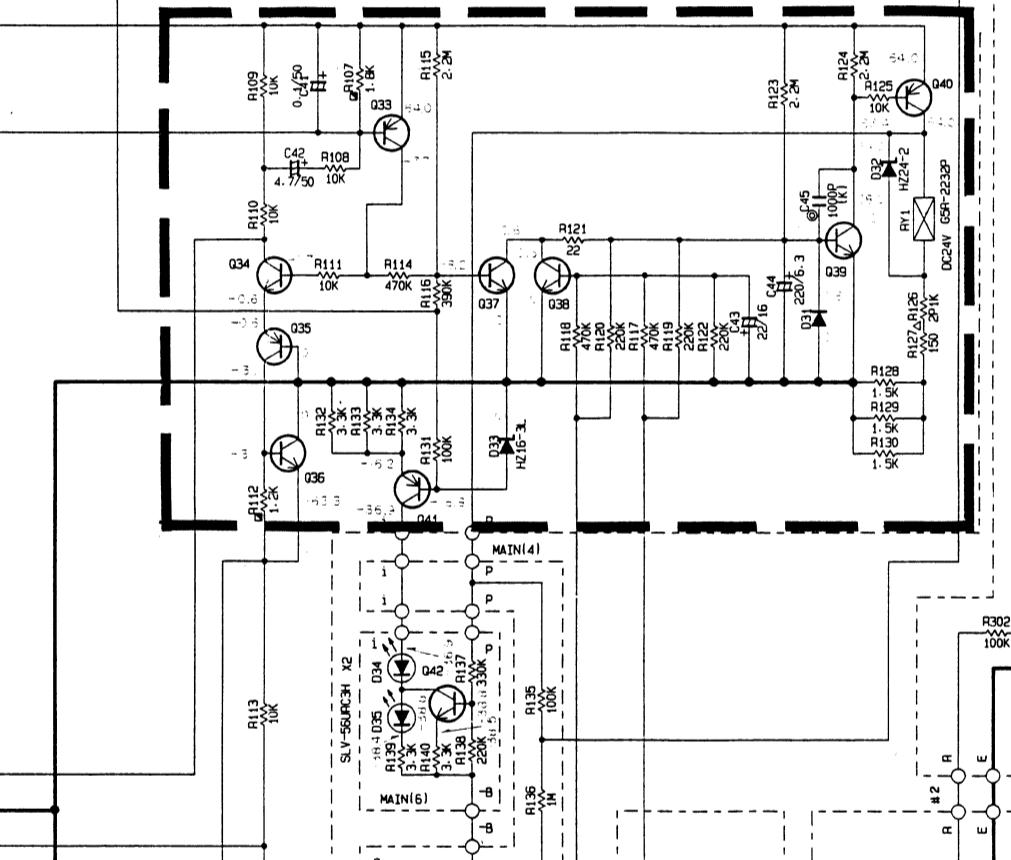

	G-B	A	R	U.C	
#1	C47-50	4700P/100	OPEN	OPEN	OPEN
#2	C51-52-61	0.011K1	OPEN	OPEN	OPEN
#3	R143-144-146-147	10	OPEN	OPEN	OPEN
#4	C57	0.1/250	OPEN	OPEN	OPEN
#8	SW4	OPEN	OPEN	V493290	OPEN
#9	F2	OPEN	OPEN	T5A250V	OPEN
#10	SW3	VE96260	OPEN	OPEN	OPEN
#12	SW2	VD94880	KAB0430	KAB0430	KAB0430
#13	C62	10P/500	OPEN	OPEN	OPEN
#14	C53-54	2200/71	2200/71	2200/71	1800/75

TR	No
2SA970(GR. BL)	01-4-033-035-041
2SA1306	021-22
2SA1145(O. Y)	011-12-40
2SC2240(GR. BL)	031-32-34-36-39-42-43
2SC1815(Y)	05-8-037-38
2SC3298	019-20
2SC2705(O. Y)	09-10-13-14
2SC3856(O. Y)	023-24-25-26
2SA1492(O. Y)	027-28-29-30
2SD1681or2SC1846S	017-18
2SB1141or2SA885S	015-16

RESISTOR

REMARKS	PARTS NAME
NO MARK	CARBON FILM RESISTOR (1/6W)
□	CARBON FILM RESISTOR
△	METAL OXIDE FILM RESISTOR
▲	METEL FILM RESISTOR
⊠	METEL PLATE RESISTOR
■	FIRE PROOF CARBON FILM RESISTOR
□	SEMENT MOLDED RESISTOR
⊗	SEMI VARIABLE RESISTOR
■	CHIP RESISTOR

CAPACITOR

REMARKS	PARTS NAME
NO MARK	ELECTROLYTIC CAPACITOR
NO MARK	CERAMIC CAPACITOR
⊙	POLYESTER FILM CAPACITOR
○	POLYSTYRENE FILM CAPACITOR
◇	MICA CAPACITOR
⊕	POLYPROPYLENE FILM CAPACITOR
●	SEMICONDUCTIVE CERAMIC CAPACITOR

\* All voltages are measured with a 10MΩ/DC electric volt meter.  
 \* Components having special characteristics are marked △ and must be replaced with parts having specifications equal to those originally installed.  
 \* Schematic diagram is subject to change without notice.

# PARTS LIST

MX-600/U/MX-50

## ■WARNING

Components having special characteristics are marked  $\Delta$  and must be replaced with parts having specifications equal to those originally installed.

• Carbon resistors (1/6W or 1/4W) are not included in the ELECTRICAL PARTS list. For the parts No. of the carbon resistor, refer to p. 19.

## ■ELECTRICAL PARTS

Ref. No.	Part No.	Description	部品名		Remarks	Common Model	Markets	リンク
※	NA:09:78:60	Main Circuit Board			メインシート		U,C	
※	NA:09:78:70	〃			〃		R	
※	NA:09:78:80	〃			〃		A	
※	NA:09:78:90	〃			〃		B,G	
	FI 32:41:00	Ceramic Cap.	0.01 $\mu$ F	250V	セラコン	C58		
	FA 15:31:00	Mylar Cap.	1000pF	50V	マイラーコン	C45		
	FA 15:32:20	〃	2200pF	50V	〃	C11,12		
	FA 15:33:30	〃	3300pF	50V	〃	C25~28		
	FA 15:41:00	〃	0.01 $\mu$ F	50V	〃	C51,52,61	B,G	
	FA 15:44:70	〃	0.047 $\mu$ F	50V	〃	C39,40		
	FU 35:05:00	Mica Cap.	5pF	500V	マイカコン	C63,64		
	FU 35:11:00	〃	10pF	500V	〃	C9,10		
	FU 35:11:00	〃	10pF	500V	〃	C62	B,G	
	FU 35:14:70	〃	47pF	500V	〃	C19~22		
	FZ 00:46:60	Metallized Cap.	0.1 $\mu$ F	250V	M M コン	C46,55,56		
	FZ 00:46:60	〃	0.1 $\mu$ F	250V	〃	C57		
	UT 45:44:70	Polypropylene Film Cap.	0.047 $\mu$ F	100V	ポリプロコン	C35~38		
	UT 45:21:00	〃	100pF	100V	〃	C3,4		
	UT 45:22:20	〃	220pF	100V	〃	C1,2,29~32,59,60		
	UT 45:34:70	〃	4700pF	100V	〃	C47~50		
	VE 01:66:00	Electrolytic Cap.	220 $\mu$ F	6.3V	ケミコンDUOREX	C7,8		
	VE 01:78:00	〃	47 $\mu$ F	16V	〃	C5,6		
	VE 01:86:00	〃	47 $\mu$ F	25V	〃	C15~18		
	VE 02:02:00	〃	10 $\mu$ F	50V	〃	C13		
※	VE 94:15:00	〃	1000 $\mu$ F	100V	オーディオケミコン	C14		
	UJ 11:82:20	〃	220 $\mu$ F	6.3V	ケミコン	C33,34,44		
	UJ 13:72:20	〃	22 $\mu$ F	16V	〃	C43		
	UJ 13:74:70	〃	47 $\mu$ F	16V	〃	C23,24		
	UJ 16:64:70	〃	4.7 $\mu$ F	50V	〃	C42		
	UJ 16:51:00	〃	0.1 $\mu$ F	50V	〃	C41		
	VC 79:37:00	Coil	1.5 $\mu$ H		クワシンコイル	L1,2		
	HL 32:34:70	Metal Oxide Film Resistor	4.7 $\Omega$	2W	酸化抵抗	R105,106		
	HL 32:61:00	〃	1k $\Omega$	2W	〃	R126		
	HL 32:63:30	〃	3.3k $\Omega$	2W	〃	R29,30		
※	HL 32:65:60	〃	5.6k $\Omega$	2W	〃	R31,32		
	HL 93:22:20	〃	0.22 $\Omega$	3W	〃	R87~94		
	HV 45:32:20	Flame Proof Carbon Resistor	2.2 $\Omega$	1/4W	不燃化カーボン抵抗	R85,86,101~104		
	HV 45:34:70	〃	4.7 $\Omega$	1/4W	〃	R28,83,84,145		
	HV 45:41:00	〃	10 $\Omega$	1/4W	〃	R141,142		
	HV 45:42:20	〃	22 $\Omega$	1/4W	〃	R21,22		
	HV 45:51:00	〃	100 $\Omega$	1/4W	〃	R33~40,79~82		
	HV 45:58:20	〃	820 $\Omega$	1/4W	〃	R23,24		
	HV 45:61:00	〃	1k $\Omega$	1/4W	〃	R45~52,61~64,75~78		
	HV 45:61:20	〃	1.2k $\Omega$	1/4W	〃	R97,98,112		
	HV 45:61:50	〃	1.5k $\Omega$	1/4W	〃	R25,26,41~44,65,66		
	HV 45:61:80	〃	1.8k $\Omega$	1/4W	〃	R107		
	HV 45:68:20	〃	8.2k $\Omega$	1/4W	〃	R95,96		
	HV 45:71:00	〃	10k $\Omega$	1/4W	〃	R67~70,99,100		
	VB 86:16:00	Pre-Set Potentiometer	822k $\Omega$		半固定抵抗	VR3,4		
	VE 64:25:00	Rotary Potentiometer	860k $\Omega$		ロータリーVR	VR1,2		

※New Parts (新規部品) NR

MX-50

MX-600/U/MX-50

Ref. No.	Part No.	Description	部 品 名	Remarks	Common Model	Markets	ランク
	iA : 09 : 70 : 00	Transistor	2SA970 (GR, BL)	ト ラ ン ジ ス タ ー	Q1~4, 33, 35, 41		
	iA : 13 : 06 : 00	//	2SA1306	//	Q21, 22		
*	iA : 11 : 45 : 00	//	2SA1145 (O, Y)	//	Q11, 12, 40		
	iC : 22 : 40 : 00	//	2SC2240 (GR, BL)	//	Q31, 32, 34, 36, 39, 42, 43		
	iC : 18 : 15 : 20	//	2SC1815 (Y)	//	Q5~8, 37, 38		
	iC : 32 : 98 : 00	//	2SC3298	//	Q19, 20		
*	iC : 27 : 05 : 00	//	2SC2705 (O, Y)	//	Q9, 10, 13, 14		
	iA : 13 : 49 : 00	Dual Transistor	2SA1349 (GR, BL)	デュアルトランジスター	IC1, 2, 7, 8		
	iC : 33 : 81 : 00	//	2SC3381 (GR, BL)	//	IC3~6		
	iF : 00 : 00 : 40	Diode	1S1555	ダ イ オ ー ド	D1~12, 23~31		
	iF : 00 : 14 : 00	//	1SS82	//	D13~22, 37		
	iF : 00 : 19 : 40	Zener Diode	HZ24-2	ツェナーダイオード	D32		
	iF : 00 : 35 : 40	//	HZ16-3L	//	D33		
	iF : 00 : 44 : 40	LED (Red)	SLV-56URC3H	L E D	D34, 35		
	iH : 00 : 11 : 60	Diode Bridge	4D4B41	ダイオードブリッジ	D36		
	KA : 80 : 48 : 60	Power Switch	TV-5	電 源 ス イ ッ チ	SW2	R, A, B, G	△
	KA : 80 : 43 : 00	//	TV-8	//	//	U, C	△
	VA : 96 : 18 : 00	Voltage Selector		電 圧 切 換 器	SW4	R	△
*	VE : 96 : 26 : 00	Slide Switch		スライドスイッチ	SW3	B, G	
*	VE : 99 : 01 : 00	Push Switch	2-2NS	プッシュスイッチ	SW1		
	VD : 37 : 09 : 00	Fuse	10A 250V	ヒ ュ ー ズ	F1	U, C	△
	KB : 00 : 14 : 90	//	10A 250V	//	//	R	△
	KB : 00 : 07 : 90	//	T4A 250A	//	//	A, B, G	△
	KB : 00 : 04 : 00	//	T5A 250V	//	F2	R	△
	VC : 27 : 86 : 00	Relay	G5R-2232P, DC24V	リ レ ー	RY1		
*	VE : 64 : 24 : 00	Pin Jack	2P	ピ ン ジ ャ ッ ク	PJ1		
	VA : 72 : 53 : 00	Wire Holder	3P	バラレルホルダー	CB5~8		
	VA : 72 : 55 : 00	//	5P	//	CB1~4		
	LB : 20 : 19 : 70	Fuse Holder Pin		ヒューズホルダーピン		U, C, R	
	LB : 20 : 10 : 60	//		//		A, B, G	
	VC : 31 : 36 : 00	Speaker Terminal	8P	スピーカーターミナル		R, A	
	VC : 72 : 08 : 00	//	8P	//		B, G	
	VF : 82 : 41 : 00	//	8P	//		U, C	
	VA : 82 : 15 : 00	Radiator		ラ ジ エ タ ー			
	BB : 06 : 95 : 10	Land Metal Fitting		ラ ン ド 金 具			
	EK : 33 : 00 : 20	Binding Head Tapping Screw	3X14(φ8)FCRM3-BI	B Wヘッドタッピングネジ			

\*New Parts (新規部品) NR

Ref. No.	Part No.	Description	部 品 名	Remarks	Common Model	Markets	リンク
※	NA 09 83 30	Meter Circuit Board	メーターシート				
	UJ 13 72 20	Electrolytic Cap. 22 $\mu$ F 16V	ケミコン	C303,304			
	UJ 16 62 20	// 2.2 $\mu$ F 50V	//	C301,302			
	UJ 13 92 20	// 2200 $\mu$ F 16V	//	C305			
	HJ 35 53 30	Carbon Resistor 330 $\Omega$ 1/4W	カーボン抵抗	R303,304			
	HJ 35 71 00	// 10k $\Omega$ 1/4W	//	R305~308,320			
	HJ 35 81 00	// 100k $\Omega$ 1/4W	//	R301,302,321,322			
	HV 45 31 00	Flame Proof Carbon Resistor 1 $\Omega$ 1/4W	不燃化カーボン抵抗	R319			
	HV 45 46 80	// 68 $\Omega$ 1/4W	//	R311~318			
	HT 37 03 40	Pre-Set Potentiometer 1k $\Omega$	半固定抵抗	VR301,302			
	HT 37 03 30	// 500 $\Omega$	//	VR303,304			
※	XA 51 40 01	IC BA681A	I C	IC301,302			
	iH 00 14 30	Diode ISR35-100A	ダイオード	D325~328			
	iF 00 35 30	Zener Diode HZ6C1L	ツェナーダイオード	D329			
	iF 00 77 10	LED SLV-31VC5	L E D	D301~324			
	LA 00 21 10	Lapping Terminal P=5 2P i-Type	i型ラッピング端子板				
	LA 00 26 50	// P=10 2P L-Type	L型ラッピング端子板				
	LB 91 80 30	Base Pin 3P i-Type	X H ベースピン				
	LB 91 80 40	// 4P i-Type	//				
	LB 65 11 20	Reflector	リフレクター				

※New Parts (新規部品) NR

# EXPLODED VIEW

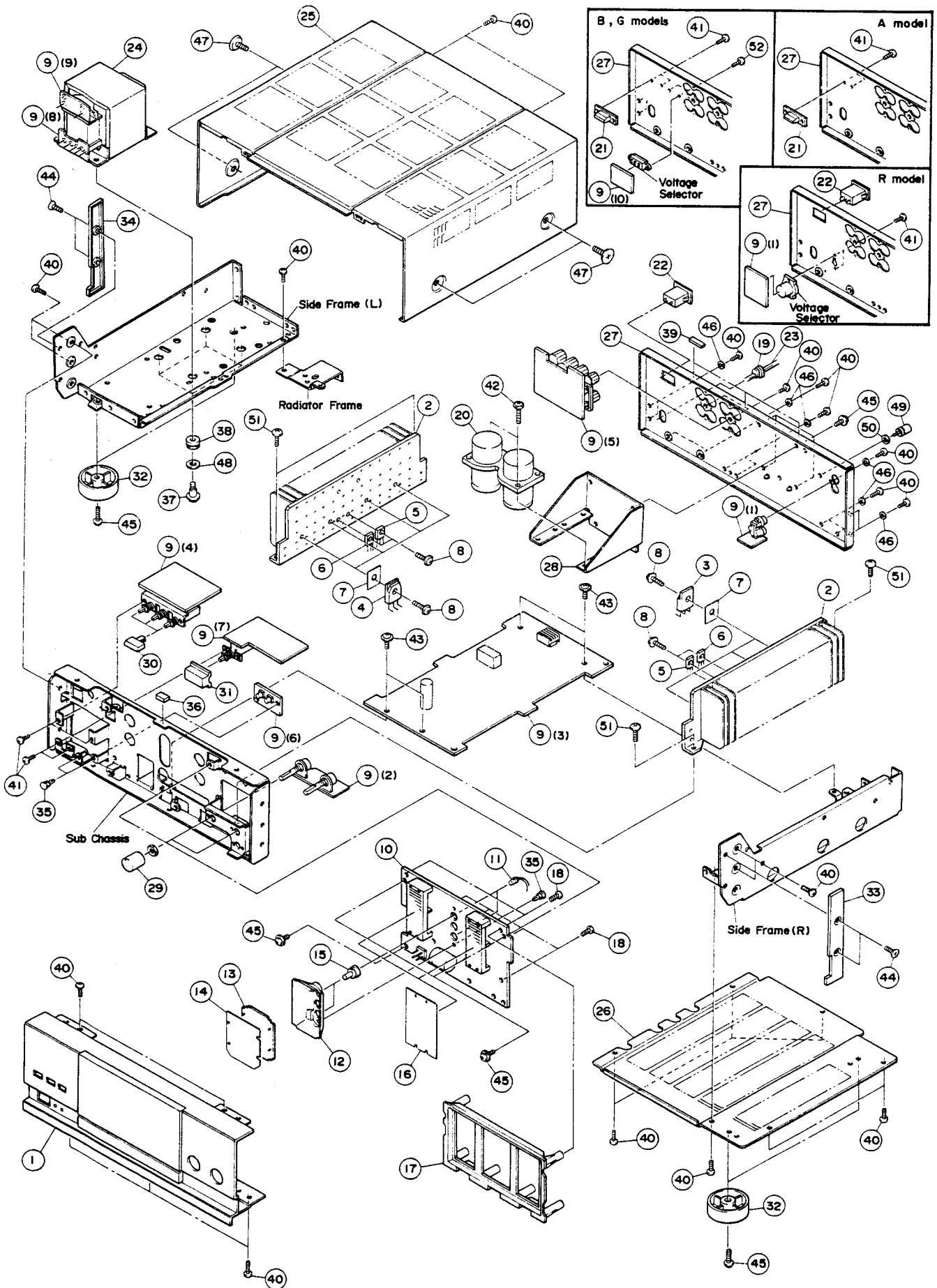



# Parts List for Carbon Resistor

Value	1/4W Type Part No.	1/6W Type Part No.	Value	1/4W Type Part No.	1/6W Type Part No.
1.0 Ω	HJ353100	HF853100	12K Ω	HJ357120	HF857120
1.8 "	HJ353180	※	15 "	HJ357150	HF857150
2.2 "	HJ353220	HF853220	18 "	HJ357180	HF857180
3.3 "	HJ353330	HF853330	22 "	HJ357220	HF857220
4.7 "	HJ353470	HF853470	27 "	HJ357270	HF857270
5.6 "	HJ353560	HF853560	33 "	HJ357330	HF857330
10 "	HJ354100	HF854100	39 "	HJ357390	HF857390
15 "	HJ354150	HF854150	47 "	HJ357470	HF857470
22 "	HJ354220	HF854220	56 "	HJ357560	HF857560
27 "	HJ354270	HF854270	68 "	HJ357680	HF857680
33 "	HJ354330	HF854330	82 "	HJ357820	HF857820
39 "	HJ354390	HF854390	91 "	HJ357910	HF857910
47 "	HJ354470	HF854470	100 "	HJ358100	HF858100
56 "	HJ354560	HF854560	120 "	HJ358120	HF858120
68 "	HJ354680	HF854680	150 "	HJ358150	HF858150
82 "	HJ354820	HF854820	180 "	HJ358180	HF858180
100 "	HJ355100	HF855100	220 "	HJ358220	HF858220
110 "	HJ355110	HF855110	270 "	HJ358270	HF858270
120 "	HJ355120	HF855120	330 "	HJ358330	HF858330
150 "	HJ355150	HF855150	390 "	HJ358390	HF858390
160 "	HJ355160	※	470 "	HJ358470	HF858470
180 "	HJ355180	HF855180	560 "	HJ358560	HF858560
220 "	HJ355220	HF855220	680 "	HJ358680	HF858680
270 "	HJ355270	HF855270	820 "	HJ358820	HF858820
330 "	HJ355330	HF855330	1.0M Ω	HJ359100	HF859100
390 "	HJ355390	HF855390	1.2 "	HJ359120	※
470 "	HJ355470	HF855470	1.5 "	HJ359150	HF859150
510 "	※	HF855510	1.8 "	HJ359180	HF859180
560 "	HJ355560	HF855560	2.2 "	HJ359220	HF859220
680 "	HJ355680	HF855680	3.3 "	HJ359330	HF859330
820 "	HJ355820	HF855820	3.9 "	HJ359390	※
910 "	HJ355910	HF855910	4.7 "	HJ359470	HF859470
1.0K Ω	HJ356100	HF856100			
1.2 "	HJ356120	HF856120			
1.5 "	HJ356150	HF856150			
1.8 "	HJ356180	HF856180			
2.0 "	HJ356200	HF856200			
2.2 "	HJ356220	HF856220			
2.4 "	HJ356240	HF856240			
2.7 "	HJ356270	HF856270			
3.0 "	HJ356300	HF856300			
3.3 "	HJ356330	HF856330			
3.6 "	HJ356360	HF856360			
3.9 "	HJ356390	HF856390			
4.7 "	HJ356470	HF856470			
5.1 "	HJ356510	HF856510			
5.6 "	HJ356560	HF856560			
6.8 "	HJ356680	HF856680			
8.2 "	HJ356820	HF856820			
9.1 "	HJ356910	HF856910			
10 "	HJ357100	HF857100			

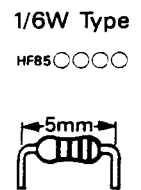
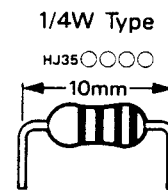

**MX-600/U/MX-50**

---

**YAMAHA**

---